

DOSSIER ELEKTRISCHE INSTALLATIE

EIGENAAR

Andre Andreas
Joseph Panterlaan 49
2010 Desselgem
123456789
123456789
a.andreas@hotmail.com

Datum: 09/11/2021

AANNEMER

ME Concept bvba
Hoveniersstraat 7
9050 Ledeberg
BE0123456789
123 456 789
info@listrik.be

Datum: 09/11/2021

KEURING

Organisatie
Naam

Datum: __/__/2021

Bijlagen
Handtekening/Stempel

DOSSIER

SITUATIE-SCHEMA paginas:	4
EEN-DRAAD-SCHEMA paginas:	4
INSTALLATIE GEGEVENS paginas:	1
MATERIAAL LIJST paginas:	1
ZEKERINGKAST MARKERINGEN paginas:	3

SOFTWARE

LISTRİK: www.listrik.be

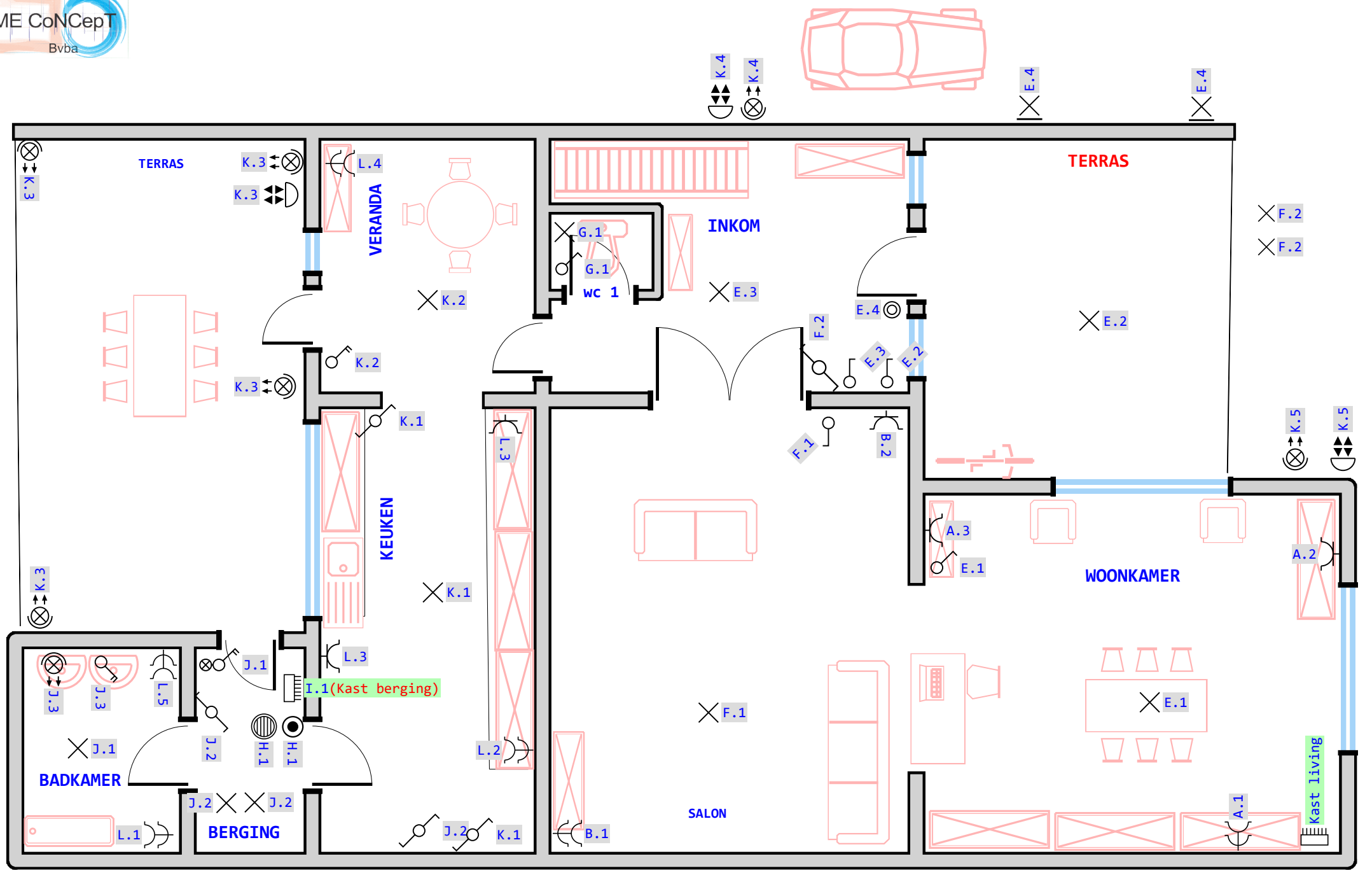

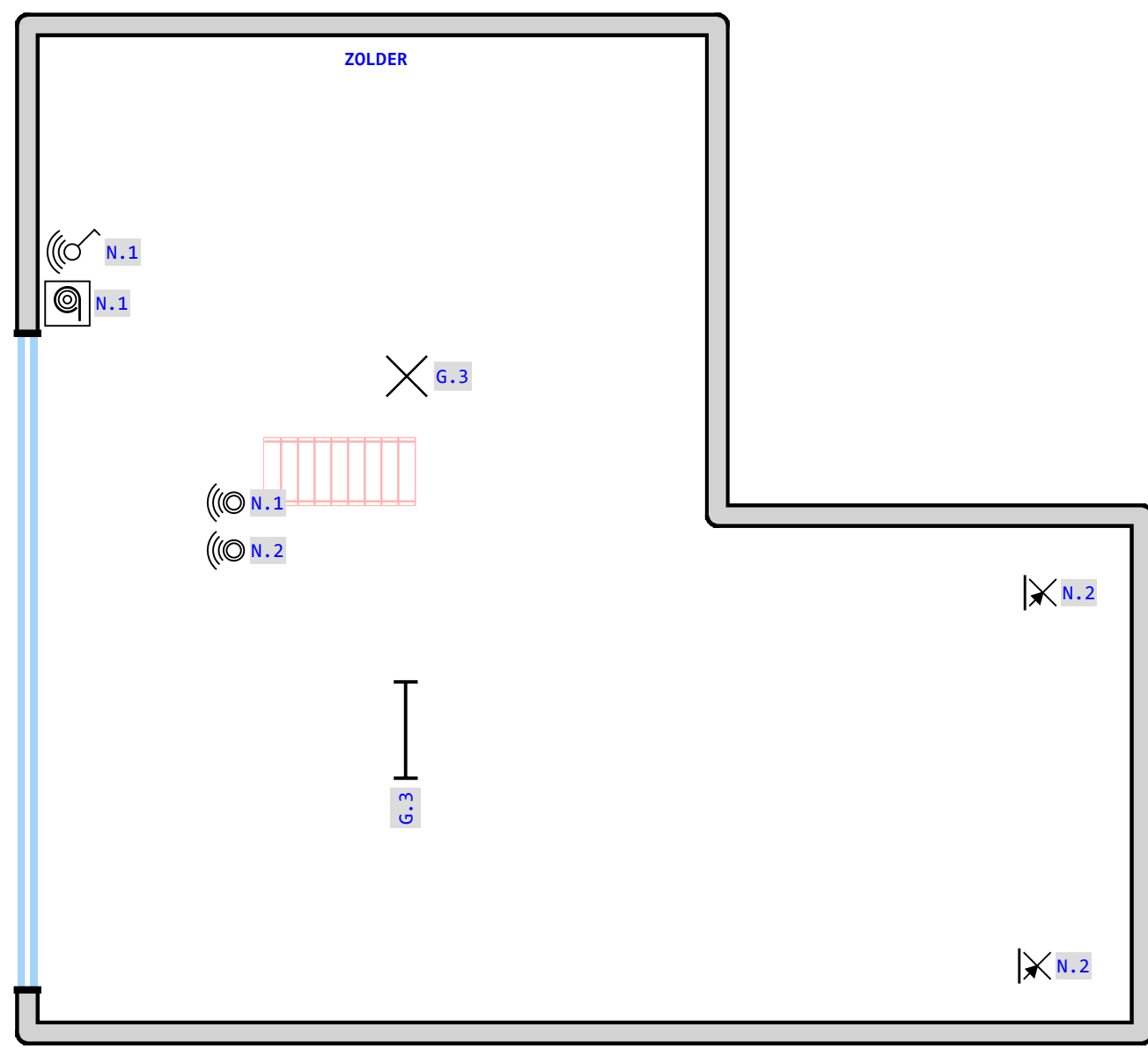

BESTAANDE JPG OPGEHAALD

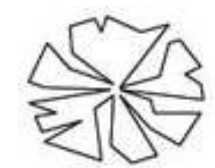
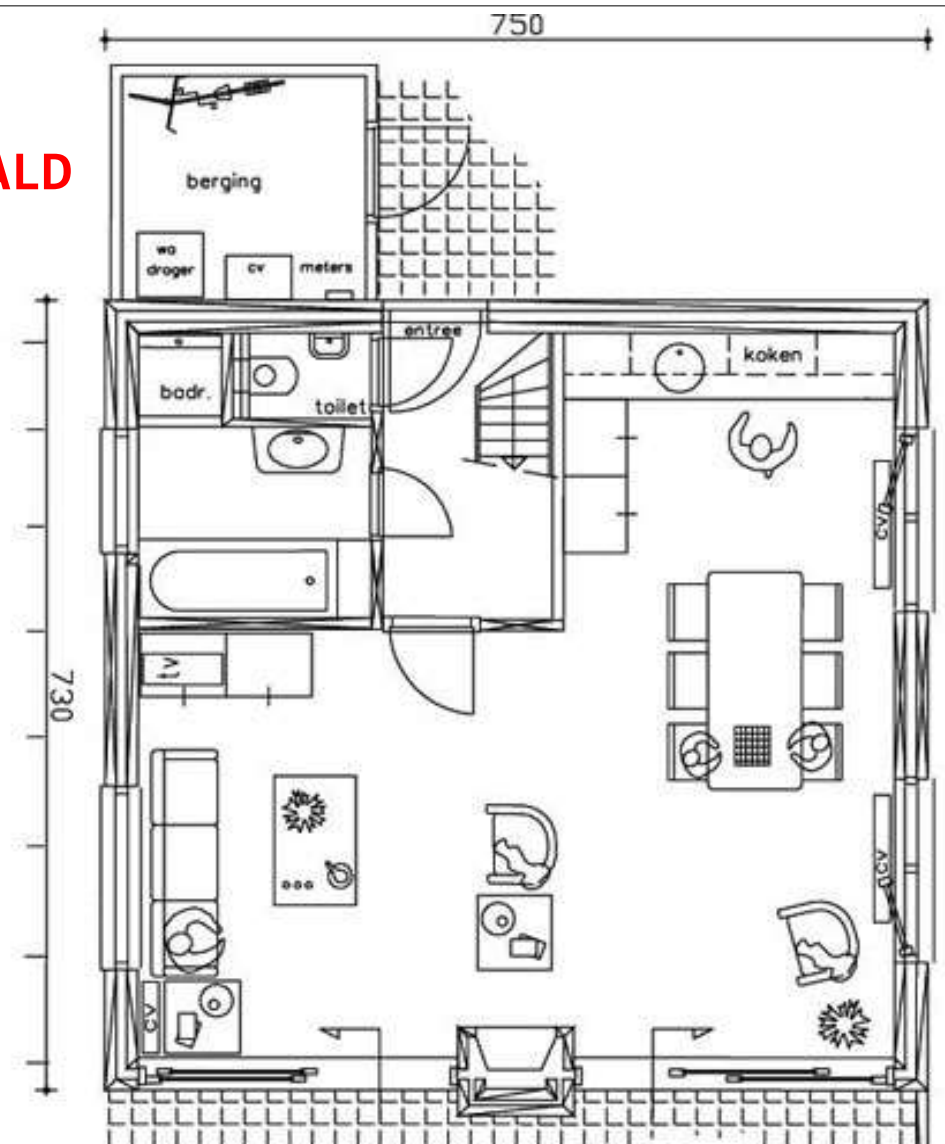
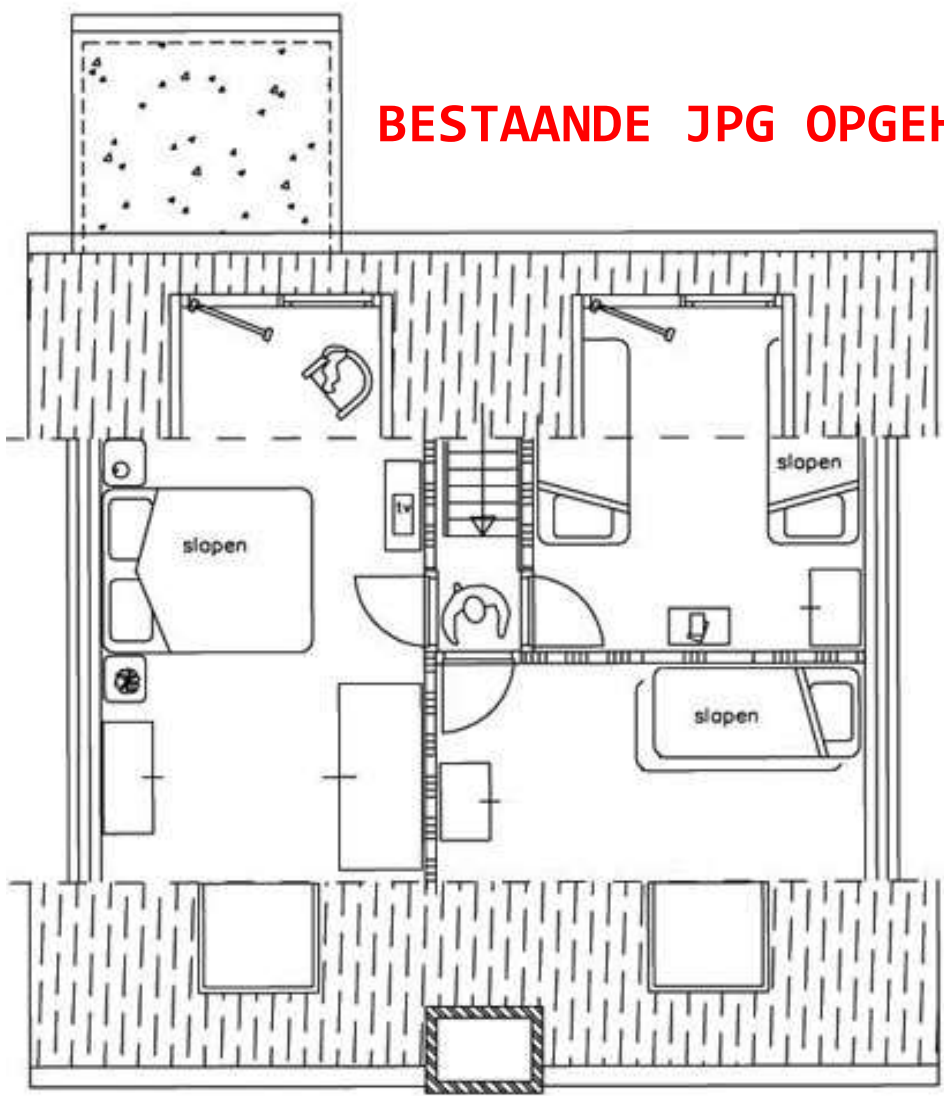

plattegrond begane grond 'Waterlelie'

plattegrond verdieping 'Waterlelie'

Voorbeeld met bestaande JPG



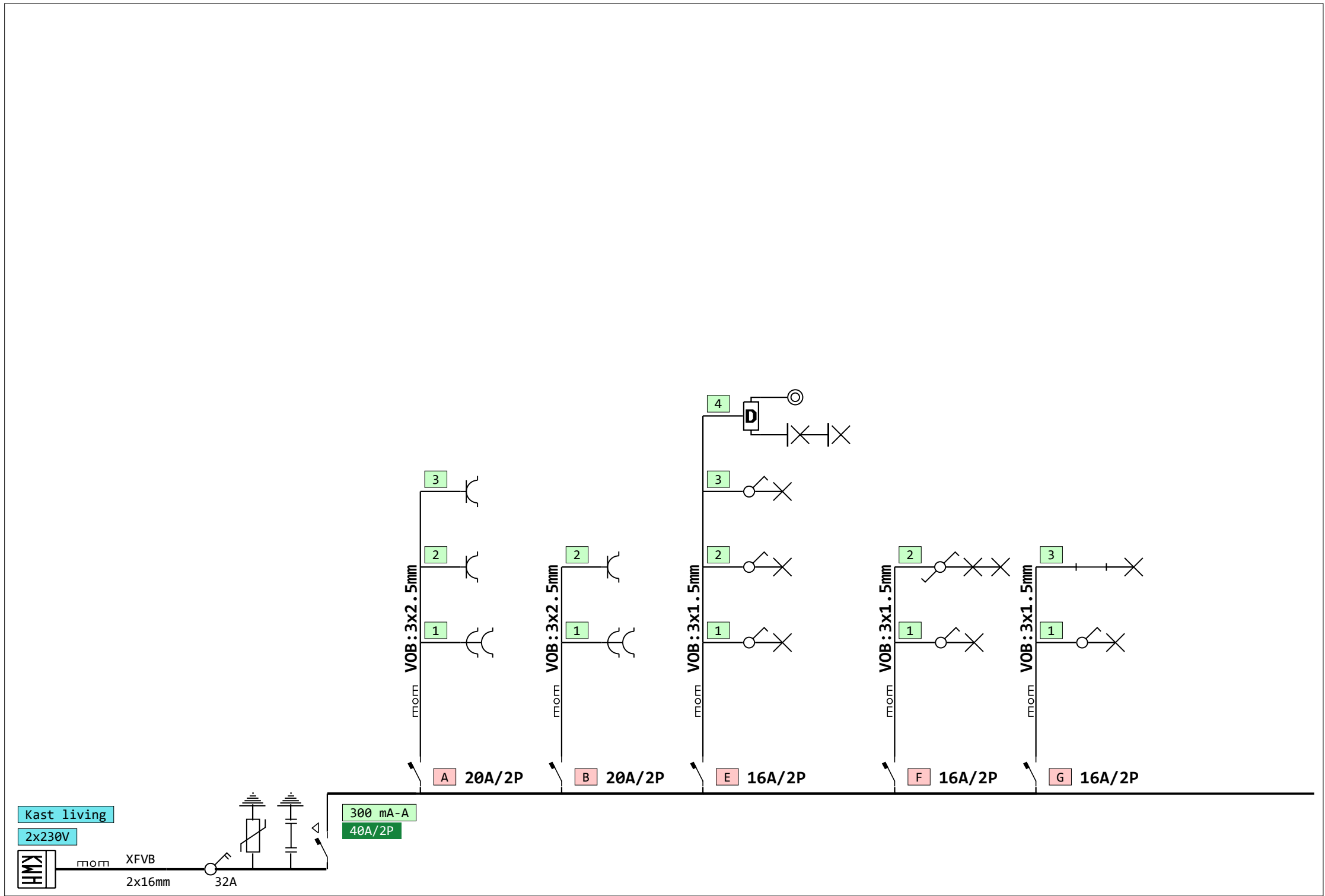

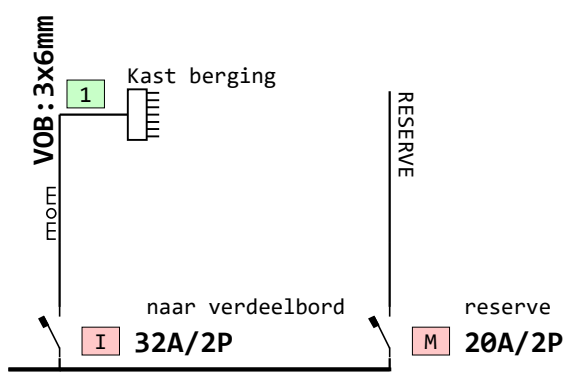

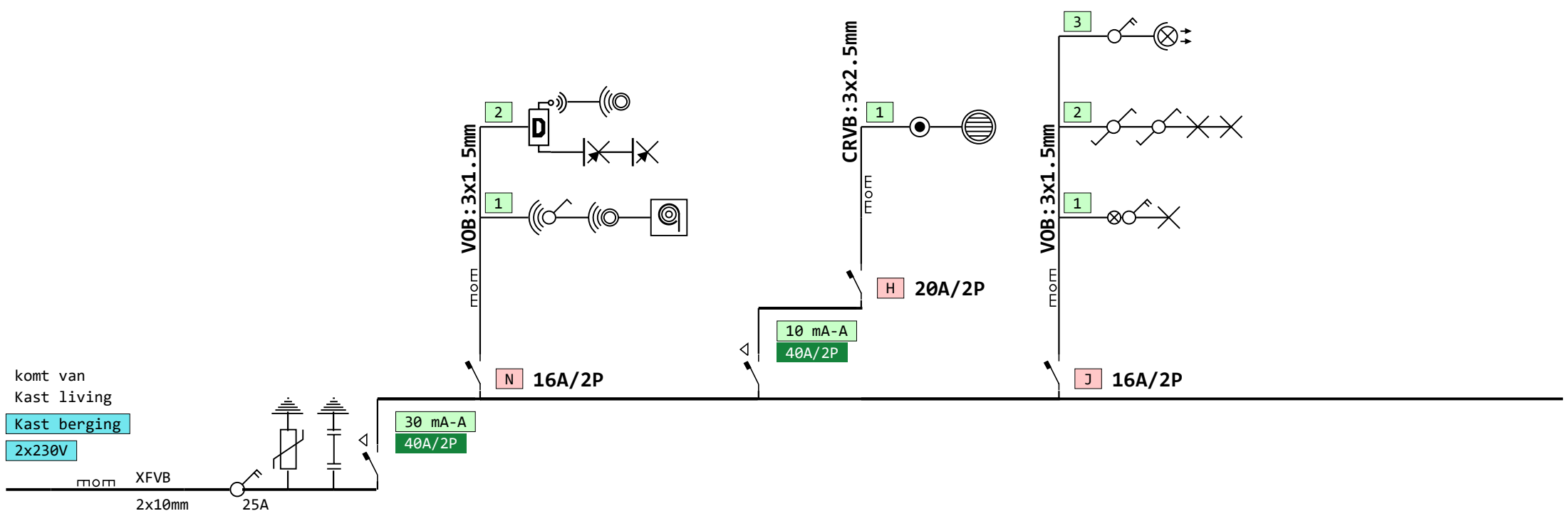

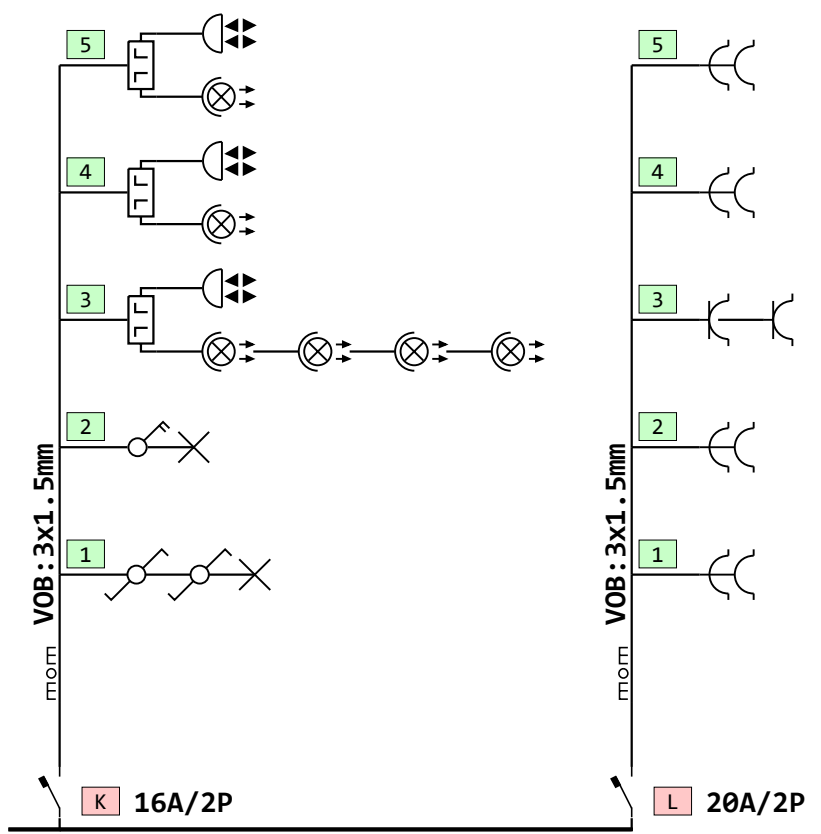































MATERIAAL LIJST

		Prijs niet geplaatst	Prijs geplaatst	
7	Bundellicht niet divergerend	0	0	
1	Fluorescentie armatuur 1	0	0	
13	Lichtpunt	0	0	
2	Wandverlichting	0	0	
2	Wandverlichting LED	0	0	
1	Domotica Module	0	0	
3	Impulsschakelaar met tijdfunctie	0	0	
3	Bewegingsdetector	0	0	
1	Drukknop	0	0	
5	Schakelaar éénpolig	0	0	
2	Schakelaar tweepolig	0	0	
1	Schakelaar tweepolig met signalisatie	0	0	
5	Wisselschakelaar éénpolig	0	0	
5	Contactdoos met beschermgeleider en kinderveiligheid	0	0	
6	Contactdoos met kinderveiligheid (2)	0	0	
1	Boiler met accumulatie	0	0	
2	Aardverbindingsstrip	0	0	
2	Aardverbinding	0	0	
1	Inbouwdoos Aftakpunt	0	0	
1	Rolluik	0	0	
2	Zekeringkast schakelaar tweepolig	0	0	
1	Schakelaar éénpolig draadloos bediend	0	0	
1	Domotica module draadloos bediend	0	0	
2	Afstandsbediening	0	0	
6	Automatische zekering(16A/2P)	0	0	
5	Automatische zekering(20A/2P)	0	0	
1	Automatische zekering(32A/2P)	0	0	
1	Differentieelshakelaar(300 mA/40A/2P)	0	0	
1	Differentieelshakelaar(30 mA/40A/2P)	0	0	
1	Differentieelshakelaar(10 mA/40A/2P)	0	0	
TOTAAL:		0	0	

ZEKERINGKAST MARKERINGEN: Kast living

300 mA:40A/2P	A: 20A/2P	B: 20A/2P	E: 16A/2P	F: 16A/2P	G: 16A/2P	I: 32A/2P	M: 20A/2P
A: B: E: F: G: I: M:						naar verdeelbord:	reserve:

ZEKERINGKAST MARKERINGEN: Kast berging

30 mA:40A/2P	N: 16A/2P			
N: 10 mA: J: K: L:				
10 mA:40A/2P	H: 20A/2P	J: 16A/2P	K: 16A/2P	L: 20A/2P
H:				

ZEKERINGKAST MARKERINGEN



**GEVAAR
LET OP!**
**DANGER
ATTENTION!**

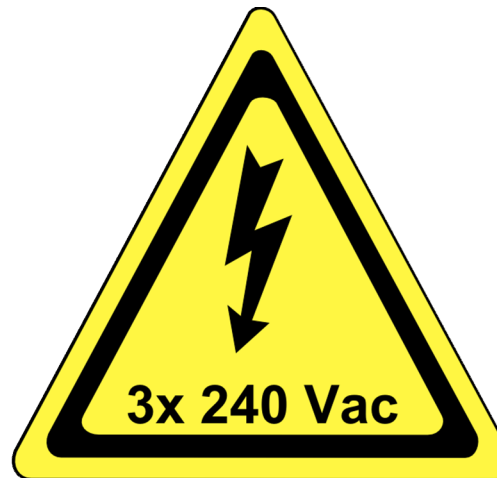

**GEVAAR
LET OP!**
**DANGER
ATTENTION!**

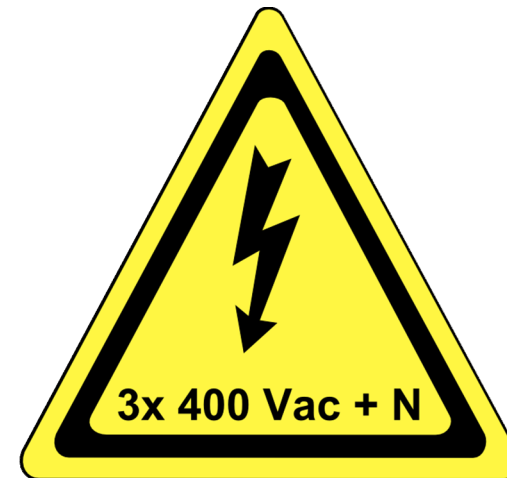

**GEVAAR
LET OP!**
**DANGER
ATTENTION!**



**GEVAAR
LET OP!**
**DANGER
ATTENTION!**

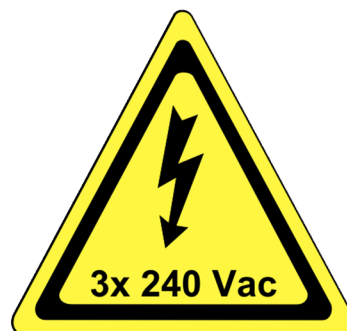

**GEVAAR
LET OP!**
**DANGER
ATTENTION!**

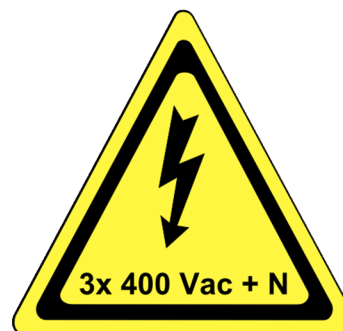

**GEVAAR
LET OP!**
**DANGER
ATTENTION!**

**GEVAAR
LET OP!**

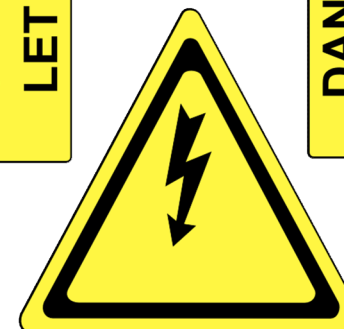

**DANGER
ATTENTION!**